



◆ **RESINDEK® FLOORING  
CARE & MAINTENANCE**

MAINTENANCE & INSTALLATION MANUAL  
FOR NON-ROBOTIC APPLICATIONS

# TABLE OF CONTENTS

## CLEANING & MAINTENANCE

---

|  |          |
|--|----------|
| Cleaning Your ResinDek® Floor .....  | <b>3</b> |
| <i>How do I clean my ResinDek® Floor?</i> .....                                    | 3        |
| <i>How do I remove tough stains?</i> .....   | 3        |
| <i>What about the expansion gaps?</i> .....  | 3        |
| <i>How can we be sure that the use of Floor Scrubbers is a safe process?</i> ..... | 3        |
| Repairing Minor Scratches .....  | <b>4</b> |
| Repairing Deep Gouges, Screw or Bolt Holes .....                                   | <b>5</b> |

## FLOOR PANEL REPLACEMENT

---

|  |          |
|--|----------|
| Panel Removal & Replacement .....                      | <b>6</b> |
| Fasteners / Fixings Installation .....                 | <b>8</b> |
| <i>Depth of Fasteners / Fixings</i> .....              | 8        |
| Grounding Screw Fasteners / Fixings Installation ..... | <b>9</b> |
| <i>ResinDek® ESD Grounding Screws</i> .....            | 9        |

## NEW FLOORING INSTALLATION

---

|   |           |
|---|-----------|
| ResinDek® Flooring Panel Installation .....   | <b>10</b> |
| <i>Care and Maintenance</i> .....   | 10        |
| <i>Note to Installers</i> .....   | 10        |
| <i>Common Installation Mistakes that Can Void your 10-Year Product Warranty</i> .....       | 11        |
| <i>Corrugated Decking</i> .....   | 12        |
| <i>ResinDek® Top Side Fasteners / Fixings in Corrugated Metal Deck</i> .....                | 13        |
| <i>ResinDek® ESD Grounding Screws</i> .....   | 14        |
| <i>ResinDek® Stand-Up Screwdriver Quick Start Guide</i> .....                               | 15        |
| <i>ResinDek® Invisi-Loc® Underside Fastening System</i> .....                               | 16        |
| <i>ResinDek® with MetaGard® Top Side Fasteners / Fixings in Corrugated Metal Deck</i> ..... | 17        |
| <i>ResinDek® with Xspan® and Xspan® FR</i> .....  | 18        |



## 1. Cleaning Your ResinDek® Floor

### *How do I clean my ResinDek® Floor?*

Whether your ResinDek® floor finish is Clear Diamond Seal®, Gray Diamond Seal® 2, Gray Diamond Seal® 2 with ESD, or TriGard®, the surface can be easily cleaned using a damp mop or standard cleaning solvents without fear of damaging the surface. Cleaning solutions that have worked particularly well include water, diluted isopropyl alcohol (3 parts water to 1 part alcohol), and many of the shelf detergents (**no degreasers**). We recommend testing a small area of the floor first with the cleaner of choice.

Avoid prolonged soaking, hosing down, or wetting of all ResinDek® products. However, walk behind scrubbers, such as Tennant micro scrubbers (see right), can provide an efficient method for daily cleaning without jeopardizing the 10 year warranty. These machines can also withdraw the liquids from the panel surfaces in a short period of time to reduce any risk of temporary edge swelling. Please ensure all pads are clean so unwanted debris is not introduced that could possibly scratch or gouge the floor finish.



### *How do I remove tough stains (i.e. grease, permanent marker, paint)?*

Acetone, also known as nail polish remover, will eliminate hard-to-remove stains and will not harm the ResinDek® finishes. **Do not use methylene chloride or paint thinners.**

### *What about the expansion gaps?*

The 1/8" (3mm) gaps will begin to shrink as the panels begin to take on humidity and moisture from the ambient conditions. Once they stop growing, they rarely open back up unless located in an uncontrolled environment in an area with extremely dry conditions. While the edges are not usually coated, standard cleaning procedures and chemicals are still acceptable. The board itself is moisture resistant and will withstand small amounts of water and other liquids.

### *How can we be sure that the use of Floor Scrubbers is a safe process?*

Cornerstone has a home improvement client that has approximately 25 different warehouse dc's in service with large elevated platforms decked with ResinDek® panels. These warehouses have been in service for an average of 3 to 4 years, and are being cleaned once per week with the same Tennant T1 Scrubbers. At a recent site visit, the floors were observed to be in excellent condition.

Using the Tennant T1 or T2 Scrubbers on the ResinDek® panels as outlined above will in no way adversely impact our 10 year warranty on this floor.



## 2. Repairing Minor Scratches

---



### 1. Contact Us

Contact Cornerstone Specialty Wood Products® for recommended touch-up paint and repair kit.



### 2. Clean Area

Thoroughly clean area to be repaired with a damp cloth. Then dry completely.

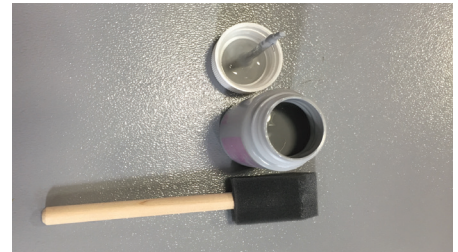

### 3. Prep Foam Brush

Depending upon the size use either the 1" (25.4mm) foam brush or the small artist brush enclosed in the kit.



### 4. Apply Touch Up Paint

Thoroughly shake the touch up paint before applying. Allow a minimum of 15 minutes for the first coat of paint to dry. If necessary add a second coat of paint.



### 5. Cure

Allow 24 hours to fully cure before touching the repaired area.





### 3. Repairing Deep Gouges, Screw or Bolt Holes



#### 1. Contact Us

Contact Cornerstone Specialty Wood Products® for recommended touch-up paint and repair kit.



#### 2. Clean Area

Thoroughly clean area to be repaired with a damp cloth. Then dry completely.



#### 3. Cut Off Repair Putty

Using a standard utility knife cut off required amount of ResinDek® epoxy repair putty.



#### 4. Mix Putty

Mix ResinDek® epoxy putty by kneading with fingers until a uniform color is achieved. If mixing is difficult, warm to room temperature or slightly above. For best results dampen fingers prior to mixing.



#### 5. Apply Putty

Apply to surface to be repaired within 10 minutes of mixing. For best adhesion force putty into any cracks or holes and strike off excess material with a tool moistened with clean water. Allow putty to cure for 60 minutes.



#### 6. Sand & Clean Area

After area has fully cured, sand area with 80 grit sandpaper, using a palm sander or sanding block. Clean area after sanding with a damp cloth to remove dust.

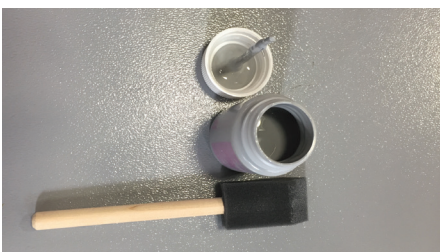

#### 7. Prep Foam Brush

Depending upon the size use either the 1" foam brush or the small artist brush enclosed in the kit.



#### 8. Apply Touch Up Paint

Thoroughly shake the touch up paint before applying. Allow a minimum of 15 minutes for the first coat of paint to dry. If necessary add a second coat of paint.

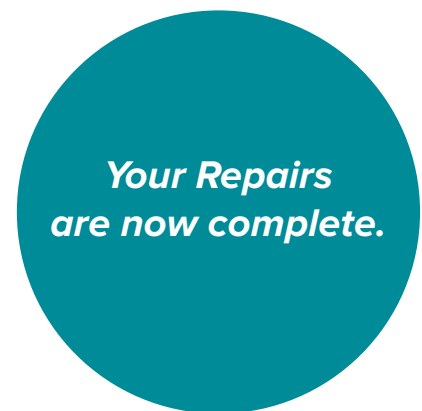



## 4. Panel Removal & Replacement

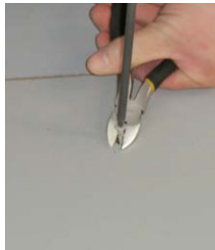
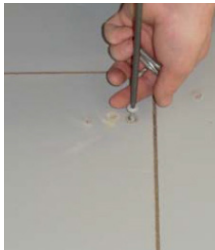

### 1. Remove Screws

Remove grounding screws, then use pliers to assist with removal of regular fasteners / fixings.

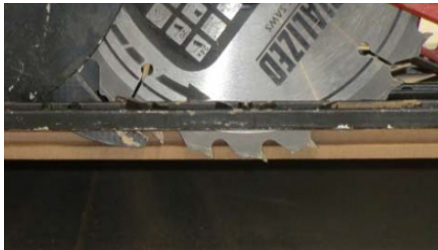

### 2. Set Circular Saw

Set circular saw to .0394" (1mm) thinner than ResinDek® Panel depth (18mm is recommended).

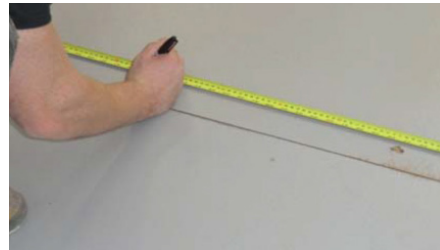

### 3. Mark Cut Centers

Mark the cut centers of the ResinDek® panels.

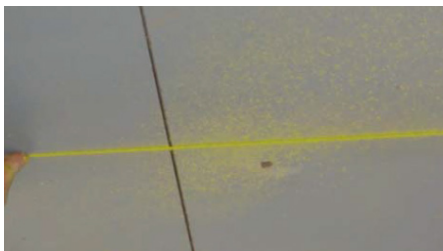

### 4. Draw Chalk Lines

Draw the chalk lines for the cuts that you are going to make.



### 5. Cut Panel

Cut the ResinDek® panel as marked with chalk line - Be careful that the B Deck is not damaged during this process by cutting too deeply.



### 6. Cut Across Internal Corner

Cut across an internal corner to assist with the panel removal.



### 7. Cut all Panel Edges

Cut all of the external ResinDek® panel edges at T&G joints. Hand chisel out remaining .0394" (1mm) of all cuts as needed.

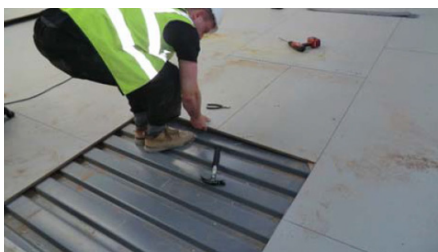

### 8. Panel Removal

Remove the internal corner piece and remove all 4 sections of the panel to be replaced.



### 9. Fit Valley Shims

Fit valley shims to all 4 sides between old adjacent panels and new to support replacement ResinDek® panel. Do not overlap valley shims.



**Panel Removal & Replacement (cont.)**

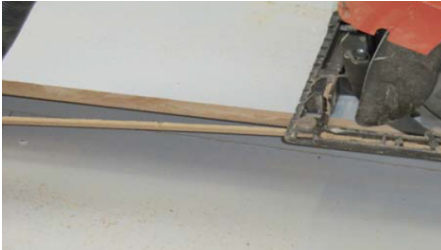

**10. Panel Tongue Removal**

Remove the ResinDek® panel tongue over the length of the replacement board - replacement panel now has 2 grooves and 2 square edges.



**11. Fit Panel into Place**

Clear all debris where the replacement ResinDek® panel is to be installed. Position replacement panel into open space.



**12. Tap Panel into Place**

Tap replacement panel into place. Ensure ResinDek® panel is central and that all perimeter edges have even gaps 0.197" (5mm).



**13. Fit Grounding Screws**

Install grounding screws at the corners.



**14. Install Counter Bores**

Using a counter bore bit, mark your rib centers. Counter bores show rib centers after they are no longer visible.



**15. Install Countersunk Screws**

Fully fix the ResinDek® panel with countersunk screws.

*For water type flooring option, see additional steps below.*

**16. Insert Foam Backer Rod**

Insert 1/4" (6.35mm) dia. foam backer rod to all (4) perimeter gaps around the ResinDek panels, pressing to the bottom of the gap.

**17. Caulk gaps**

Use a manual dual tube caulk gun to fill the gaps with JF-311 Polyurea joint filler per manufacturer instructions.





## 5. Fasteners / Fixings Installation

### Depth of Fasteners / Fixings

Care should be taken to install ResinDek® fasteners / fixings in accordance with Cornerstone Installation Instructions. The proper depth is important for cosmetic, but not structural reasons. The diagram below (*Figure E*) illustrates the proper depth of the fixing vs. the fasteners / fixings installed too deep, and not deep enough.



*ResinDek® Top Side Fasteners /  
Fixings*  
Part No. COR8030 (Gray)  
Part No. COR8038 (Beige)

*Figure E.*

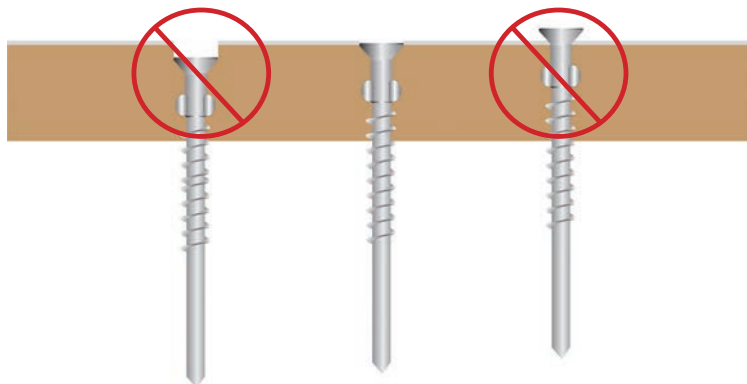

When fasteners / fixings are installed too deeply, mounding of the ResinDek® panels can sometimes occur. This is cosmetic, not a structural problem, and will not impact the 10-year warranty. This problem can be prevented by using the counter bore bits prior to screw installation as shown in this photo. In addition to preventing mounding, and controlling screw depths better, the counter bores serve to locate the center of rib locations after the panel has been laid in place.

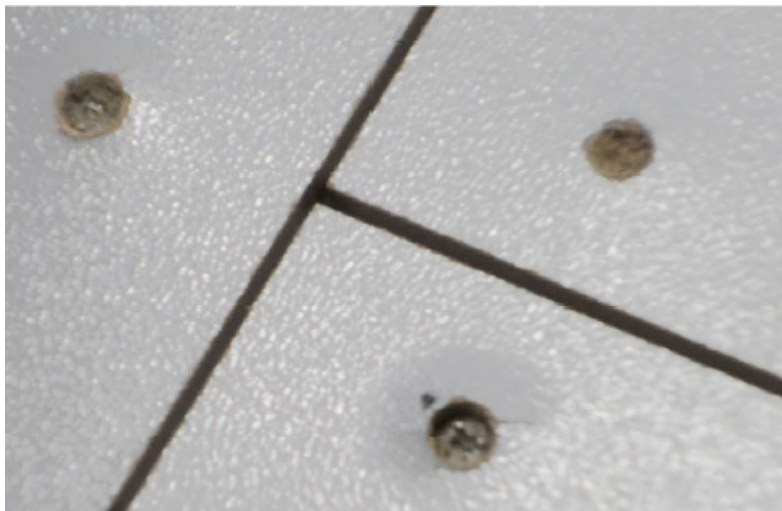



## 6. Grounding Screw Fasteners / Fixings Installation

### ResinDek® ESD Grounding Screws

For proper grounding performance of ResinDek® Gray Diamond Seal® 2 ESD, TriGard® ESD or MetaGard® panels install four (4) grounding screws on any panel that is 4'x8' (1220mm x 3048mm) or less. Larger panels will require additional grounding screws. Examples of grounding screw installation patterns can be seen below (Figure F). Distance to the closest screw must not exceed 4' (122mm), regardless of panel size.

**PROPERLY INSTALLED GROUNDING SCREWS ARE NECESSARY FOR A FULLY COMPLIANT ESD FLOOR.**

The underside of the grounding screw head must be installed flush with the top surface of the panel. Be careful to not strip out screws from the corrugated decking. ResinDek® panels attached to the corrugated metal deck requires a minimum of 0.625 screws per 1 sqft (0.093 m<sup>2</sup>) which equals 20 screws per 4'x8' (1220mm x 3048mm) sheet. For panels that have ResinDek® Gray Diamond Seal® 2 ESD or TriGard® ESD coating, the grounding screws will count towards the minimum requirement of fasteners / fixings.

Figure F - ESD Screw Installation

Cross Section - Screws must be flush with deck surface!



ResinDek ESD  
Grounding Screw  
Part No. COR8005

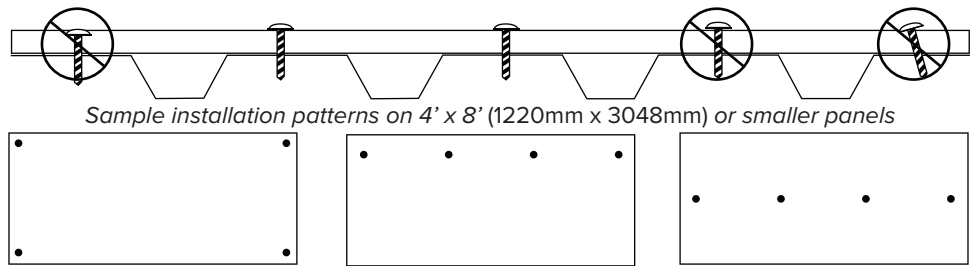

Also, for best results, care should be taken to install the fasteners / fixings at least .984" (25mm) from the edge of the panels.

If ESD panels are selected, Grounding Screws are to be used to dissipate static charges generated by the contact and separation between the flooring surface and shoes or wheels. These screws are designed to be installed such that the screw heads rest on top of the surface, rather than below the surface per above sketch.



The left photo shows an example where the grounding screws were installed too deeply. In this instance, the depth of the grounding screw may adversely impact its ability to transmit the charge away from the panel surface into ground. It is recommended that an additional grounding screw be installed adjacent to the improperly installed screw.



The photo at right shows an example where the grounding screw was installed correctly.

### Grounding Screw Scenario

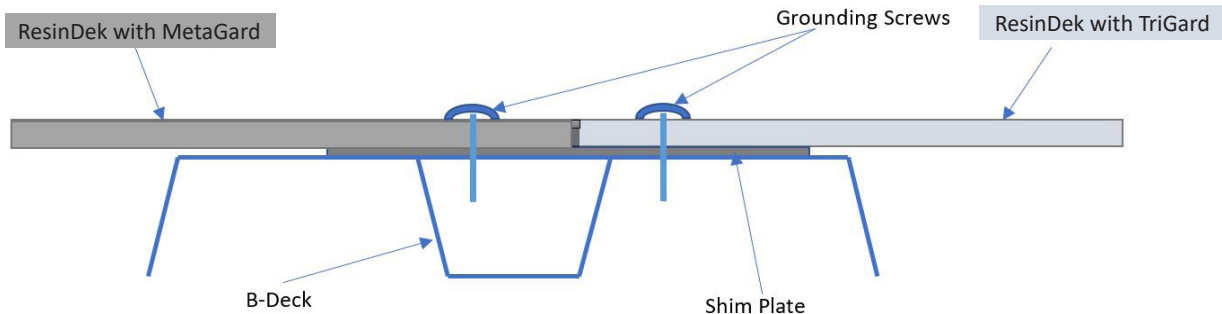



## 7. ResinDek® Flooring Panel Installation

### Care and Maintenance

ResinDek® flooring provides long-lasting durability, but must be properly installed and maintained to avoid costly floor problems, repairs and hazards that may potentially void all product warranties. Whether your ResinDek® floor finish is Gray Diamond Seal® 2, Gray Diamond Seal® 2 ESD or TriGard® ESD, the surface can be easily cleaned using a damp mop or standard cleaning solvents without fear of damaging the surface. Cleaning solutions that have worked particularly well include water, diluted isopropyl alcohol (3 to 1 mix), and many off the shelf detergents and floor cleaners. **NEVER USE METHYLENE CHLORIDE, DEGREASERS OR PAINT THINNERS WHICH WILL DAMAGE THE RESINDEK® FINISH. ALSO AVOID PROLONGED SOAKING, HOSING DOWN, OR WETTING OF ALL RESINDEK® PRODUCTS.** ResinDek® UF (unfinished) will clean up similar to other unfinished wood products.

Contact Cornerstone Specialty Wood Products, LLC® for a touch up kit if you need to repair minor scratches on ResinDek® floor panels, deep gouges, screw or bolt holes. All cracks and holes should be investigated since these are primarily due to loads in excess of ResinDek® recommendations. Excessive load damage to ResinDek® panels cannot always be repaired, and may need to be replaced. Please contact us and we will be happy to assist you in determining the cause of the panel damage and how best to repair it in accordance with the ResinDek® product warranty.

### Note to Installers

ResinDek® is not intended for exterior applications. **RESINDEK® PRODUCTS NOT INSTALLED IN ACCORDANCE WITH THE FOLLOWING INSTRUCTIONS WILL VOID ALL WARRANTIES.** ResinDek® panels must be kept dry during transit and storage. Panels should be stored flat in a level position.

ResinDek® should be installed over an approved corrugated metal deck or an existing mezzanine floor surface. Refer to page 4 to confirm metal deck is properly fastened down per approved installation instructions. Substructures must be capable of supporting the loads in the chart below. Failure of substructure may result in local failure of ResinDek®. A minimum of 20 gauge steel is required when using corrugated metal B Deck or N Deck. 18 gauge is recommended for loads exceeding 2,500lbs (1134 kg).

**CONFIRM THAT THE WEIGHT OF THE UNIT WILL NOT EXCEED THE CAPACITY OF THE PANEL PRIOR TO MOVING IT ACROSS A FINISHED RESINDEK FLOOR. THESE VALUES ARE BASED ON A STANDARD MANUAL PALLET JACK. SEE PAGE 8 FOR RESINDEK® WITH METAGARD® WEIGHT AND LOAD TABLE.**

| Product             | Weight (psf) / (kg/m <sup>2</sup> ) | Pcs per Unit | Weight per Unit for 4'x6' (1.22m x 1.83m) panels (lbs) / (kg) | Weight per Unit for 4'x8' (1.22m x 2.44m) panels (lbs) / (kg) | Weight per Unit 4'x10' (1.22m x 3.05m) panels (lbs) / (kg) | Rated Pallet Jack Load Capacity (lbs) / (kg) |
|---------------------|-------------------------------------|--------------|---|---|--|--|
| ResinDek® LD        | 2.8 (13.7)                          | 36           | 2,419 (1,101)   | 3,226 (1,468)   | 4,032 (1,835)  | 2,000 (907)                                  |
| ResinDek® SD        | 3.1 (15.1)                          | 32           | 2,381 (1,079)   | 3,174 (1,438)   | 3,968 (1,798)  | 2,500 (1,134)                                |
| ResinDek® MD        | 3.5 (16.6)                          | 32           | 2,688 (1,222)   | 3,584 (1,629)   | 4,480 (2,036)  | 3,500 (1,588)                                |
| ResinDek® HD        | 3.8 (18.6)                          | 32           | 2,918 (1,329)   | 3,891 (1,772)   | 4,864 (2,215)  | 4,500 (2,041)                                |
| ResinDek® Xspan®    | 5.2 (25.4)                          | 21           | 2,621 (1,191)   | 3,494 (1,588)   | 4,368 (1,985)  | 2,300 at 32" O.C.<br>(1,043 at 810mm O.C.)   |
| ResinDek® Xspan® FR | 6.0 (29.3)                          | 21           | 3,024 (1,374)   | 4,032 (1,832)   | 5,040 (2,290)  | 3,000 at 32" O.C.<br>(1,361 at 810mm O.C.)   |

### WARNING: UNDER CONDITIONS OF EXTREME HUMIDITY, RESINDEK® MAY BE PRONE TO LINEAR EXPANSION.

ResinDek® panels, like most other mezzanine floor panels in the industry, are prone to linear expansion. Because ResinDek® panels are extremely dense and don't crush under load, they are particularly susceptible to buckling if the panels expand into adjacent panel edges. Once maximum growth is achieved, the gaps rarely shrink and remain quite stable. We manufacture the panels 1/8" (3mm) under nominal dimensions to allow for gapping. When spaced properly, a nominal 4'x8' (1.22m x 2.44m) panel will take up exactly 48" x 96" (1.22m x 2.44m) of floor space.



## ResinDek® Flooring Panel Installation (cont.)

 **Common Installation Mistakes that Can Void your 10-Year Product Warranty**

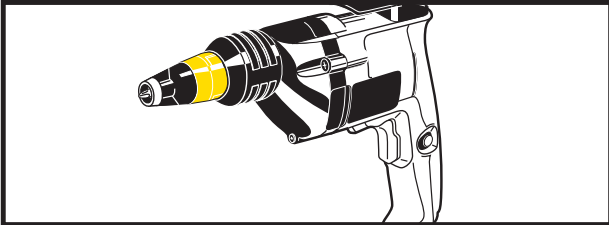

Must use screw driver/gun with operable clutch for consistent screw depth setting. For best results use stand-up screw gun.

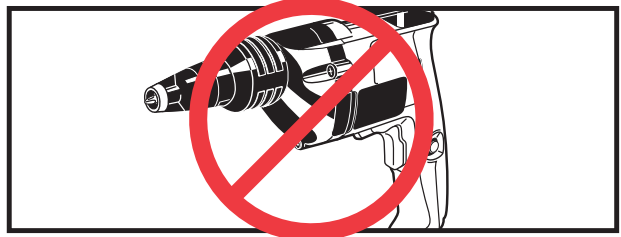

Do not use screw driver/gun with no clutch or a broken clutch.

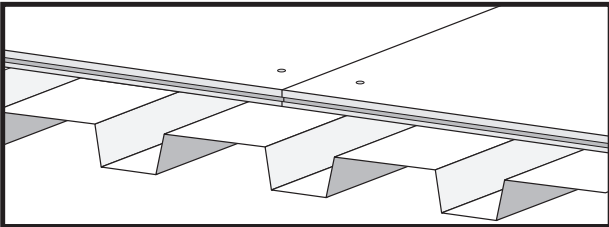

Panels must meet on high points (ribs) of corrugated deck

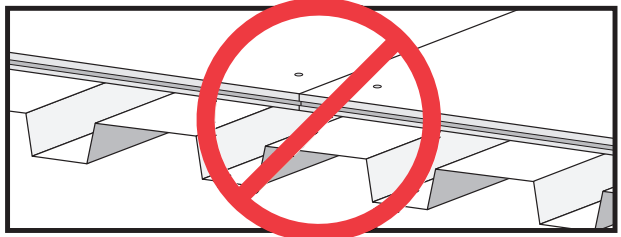

Do not place panel edges on top of corrugated deck low points (valley).

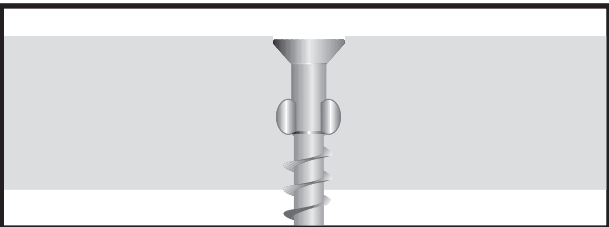

Approved screws must be placed just below the panel surface.

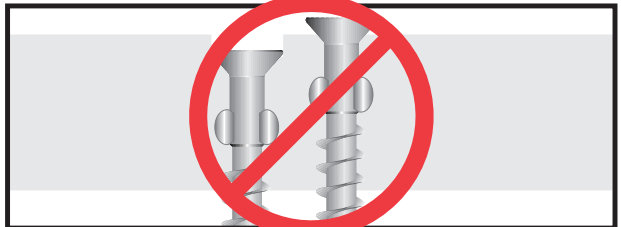

Do not place approved screws too high or too low in the panels.

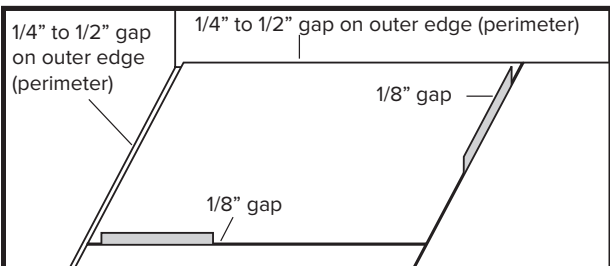

Use 1/8" (3mm) spacer between panels for correct spacing. The gap on the outer edge (perimeter) must not be less than a 1/4" (6mm) or exceed a 1/2" (12mm). [See page 8 for ResinDek® with MetaGard® gapping recommendation.](#)

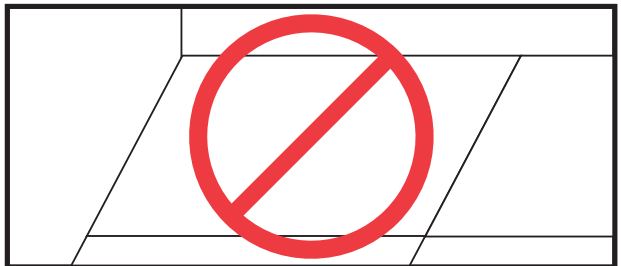

Do not install panels without an 1/8" (3mm) gap between panels and a minimum of a 1/4" (6mm) to a maximum 1/2" (12mm) gap on the outer edge (perimeter) of the panels.

**FAILURE TO INSTALL RESINDEK® AS INSTRUCTED WILL VOID ALL WARRANTIES.**



## ResinDek® Flooring Panel Installation (cont.)

### Corrugated Decking

If corrugated deck instructions or drawings were not provided, please refer to the American National Standard/Institute Steel Deck RD-2017 Standard for Steel Roof Deck - <http://www.sdi.org/wp-content/uploads/2017/02/ANSI-SDI-RD-2017-Standard.pdf>

In addition to the document above, please consider the following when installing corrugated deck:

- Please ensure the correct side is up.
- Recommend using structural screws to properly secure the metal deck. Other types of SDI approved methods could lead to elevation issues, which can cause installation difficulty and potential failures when used with wheel loads.
- When overlapping in the width direction, ensure panel spacing remains consistent (for example B-Deck rib should be on 6" (152mm) centers). Failure to do so could result in an increase need for valley shims, cutting of panels, or elevation issues.
- During layout do not over crowd panels; it is best to install and secure the panels one at a time.
- The corrugated metal deck should be installed with a levelness tolerance of +/- 1/8" (3mm) over a 24" (610mm) distance.
- Once installed we recommend that you remove debris and excess fasteners / fixings prior to installing the ResinDek® flooring panels.

### ResinDek® Top Side Fasteners / Fixings in Corrugated Metal Deck

**NOTE: Instructions below are for ResinDek® Panels with Gray Diamond Seal® 2, TriGard®, and UF (unfinished) only.**

Begin your floor installation by reviewing all approved drawings and instructions. If drawings were provided, install per installation drawings. If drawings were not provided, stagger the floor panels in a brick pattern.

- Use a laser, transit, chalk line, or string to set a true line less than 48" (1219mm) from one edge of the mezzanine to align the long edge of the panel. This will allow you to trim panels for proper spacing around the perimeter.
- ResinDek® panels can be laid parallel to the corrugated metal deck, perpendicular is the preferred direction.
- Make sure the panels are installed with the correct surface on top. Located on the edge of each ResinDek® panel is a stamped part number. When correctly installed, the stamp will be right side up.
- To avoid weak joints that may damage your floor, take caution to lay the panels down with the joints over the ribs whenever possible (**Figure A**). Panels must be cut back, or placed on top of a minimum 6" (152mm) wide, 20-gauge valley shim, when ResinDek® panels break on a valley (**Figure B**). These valley shims can be obtained from Cornerstone Specialty Wood Products, LLC®. Do not use wood blocks in the valley of the decking, as they may cause the panel joints to become uneven. **PLACING RESINDEK® PANEL JOINTS ON VALLEYS WITHOUT PROPER VALLEY SHIMS WILL VOID YOUR WARRANTY.**
- ResinDek® panels are a wood based product and may expand over time. Therefore, you must leave an 1/8" (3mm) minimum gap between ResinDek® panels. The gap on the outer edge (perimeter) must not be less than a 1/4" (6mm) or exceed a maximum of a 1/2" (12mm) (**Figure C**).
- Attached to each ResinDek® bundle is a package that includes installation instructions and three 1/8" (3mm) thick metal panel spacers. Between all adjacent panels insert the metal spacers, two along the long edge and one along a short edge, to ensure proper gapping between the panels. **FAILURE TO USE METAL PANEL SPACERS MAY ALLOW FLOOR TO BUCKLE AND WILL VOID ALL WARRANTIES.**
- It is essential to trim the last row of panels to allow for a 1/4" (6mm) to a 1/2" (12mm) gap along the outer edges of the ResinDek® floor perimeter. You can trim ResinDek® panels to size with a circular saw. Carbide tip blades are recommended for best results.

Figure A.

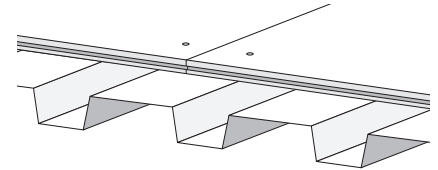

Figure B.

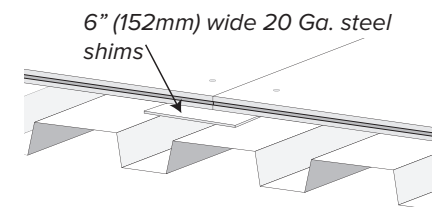
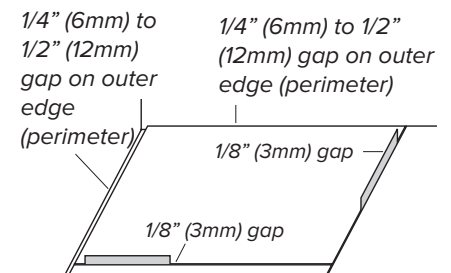

Figure C.





# ResinDek® Flooring Panel Installation (cont.)

## ResinDek® Top Side Fasteners / Fixings in Corrugated Metal Deck (cont.)

- Attach ResinDek® panels to the corrugated metal deck using a minimum of 0.625 screws per 1 sqft which equals 20 screws per 4'x8' (1220mm x 3048mm) sheet (Figure D). If your panel has an ESD based coating, a minimum of four grounding screws will be required per 4'x8' (1220mm x 3048mm) panel, which will count towards the minimum screw requirement. Refer to the ESD Grounding Screw installation instructions found below or watch the ESD Grounding Screws installation video for more information.
- Screws must penetrate both the ResinDek® panel and the corrugated metal deck. **FAILURE TO USE APPROVED SCREWS MAY VOID ALL WARRANTIES ON RESINDEK FLOOR PANELS.** For best results always use ResinDek® screws furnished by Cornerstone Specialty Wood Products, LLC.
- Use a white chalk line (for ease of cleaning) to mark a grid for locating the screws, making sure to locate all screws a minimum of 1" (25mm) from panel edges.
- Secure each panel with a minimum of two screws before installing the next panel and removing the panel spacers. When fastening panels use only a screwdriver with a clutch or depth limiter to properly counter sink screw heads. Cornerstone Specialty Wood Products recommends and sells a 2500 RPM Senco® Stand-up Screwdriver. Please refer to our website for more information.
- Drive screws so that the top is just below the panel surface (Figure E). Proper screw head depth is critical to performance and appearance of your ResinDek® floor. Use caution, as backing out or removing improperly installed screws may damage the panel.

Figure D.

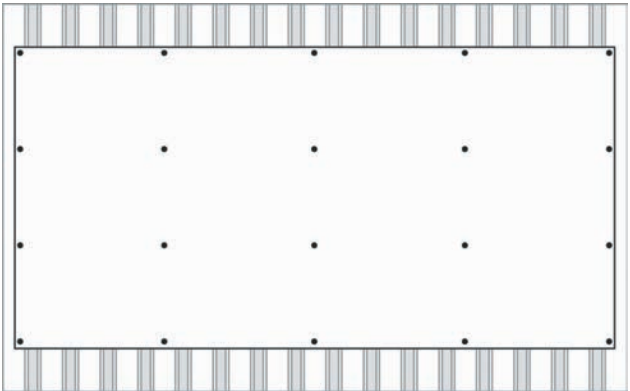
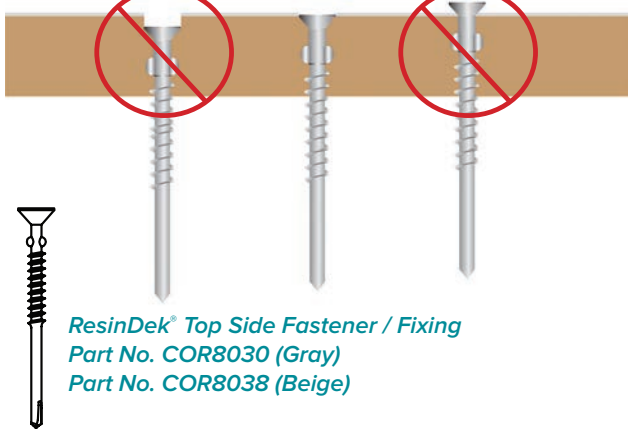

Figure E.





## ResinDek® Flooring Panel Installation (cont.)

### ResinDek® ESD Grounding Screws

For proper grounding performance of ResinDek® Gray Diamond Seal® 2 ESD and TriGard® ESD panels install four (4) grounding screws on any panel that is 4'x8' (1220mm x 3048mm) or less. Larger panels will require additional grounding screws. Examples of grounding screw installation patterns can be seen below (*Figure F*). Distance to the closest screw must not exceed 4' (1220mm), regardless of panel size. **PROPERLY INSTALLED GROUNDING SCREWS ARE NECESSARY FOR A FULLY COMPLIANT ESD FLOOR.**

The underside of the grounding screw head must be installed flush with the top surface of the panel. Be careful to not strip out screws from the corrugated decking.

ResinDek® panels attached to the corrugated metal deck requires a minimum of 0.625 screws per 1 sqft (0.093 m<sup>2</sup>) which equals 20 screws per 4'x8' (1220mm x 3048mm) sheet. For panels that have ResinDek® Gray Diamond Seal® 2 ESD or TriGard® ESD coating, the grounding screws will count towards the minimum requirement of fasteners / fixings.

*Figure F - ESD Screw Installation*  
Cross Section - Screws must be flush with deck surface!

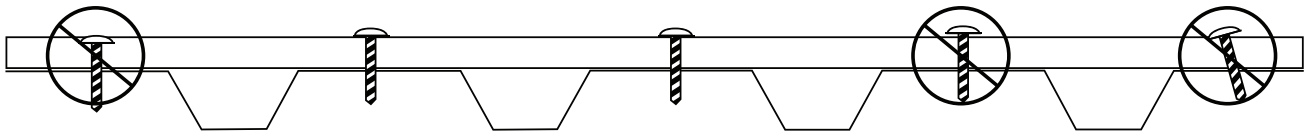

*Sample installation patterns on 4' x 8' (1220mm x 3048mm) or smaller panels*

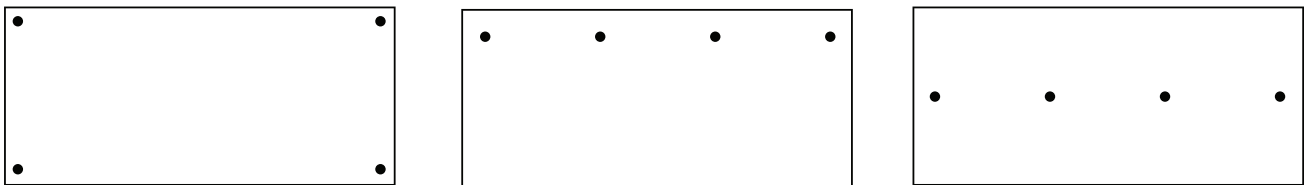

*ResinDek® ESD  
Grounding Screw  
Part No. COR8005*



# ResinDek® Flooring Panel Installation (cont.)

## ResinDek® Stand-Up Screwdriver Quick Start Guide

**\*\*SAFETY INFORMATION:** The safe operation and use of tools with their accessories are important! Always use the tool in complete compliance with the manufacturer’s instructions. Always consult the tool manual for proper use and safety equipment requirements.



Confirm the adapter set screw is tight.



Screw the extension tube onto the screw gun adapter.



Slip drill handle over extension tube and tighten down.



Insert bit tip into center of rod inside the extension tube. Push down until rod clicks into place.



Install the auto-feed end assembly by slipping it over the top of the extension tube and tighten down with the screw adapter until snug.



The screw gun is preset from the factory for a 2” (51mm) screw. Confirm that is still set at the 2” (51mm) mark.



Feed strip into slide body until the 2nd empty slot is aligned with the bit. The tool will feed the first screw when depressed against the work surface.



To remove the strip, pull it through the auto-feed end assembly.



Be sure the screwdriver is operating forward (clockwise) direction. The screw will not advance and bit will be damaged otherwise.



Pull trigger to start motor, press the footplate with constant force against work surface. Do not remove tool from the work until clutch disengages and the bit stops rotating, signaling a fully driven screw. The next screw will be auto fed into place when the tool is removed from the work. This tool has a depth-sensing clutch and will auto disengage making a click ratcheting noise signaling a completed drive.



Adjust screw depth by turning the depth adjustment thumb wheel. Refer to the graphics on the tool for proper direction.





## ResinDek® Flooring Panel Installation (cont.)

### ResinDek® Invisi-Loc® Underside Fastening System

Begin your floor installation by reviewing all approved drawings and instructions. If drawings were provided, install per installation drawings. If drawings were not provided, stagger the floor panels in a brick pattern.



- If corrugated metal deck has been pre-punched, skip to next step. Otherwise, drill 17/64" (6.8mm) holes in corrugated deck using **Figure A** as a template. Holes should be drilled in 6" (152mm) grid pattern.
- Use a laser, transit, chalk line, or string to set a true line less than 48" (1.22m) from one edge of the mezzanine to align the long edge of the panel. This will allow you to trim panels for proper spacing around the perimeter.
- ResinDek® panels can be laid parallel to the corrugated metal deck, perpendicular is the preferred direction.
- Make sure the panels are installed with the correct surface on top. Located on the edge of each ResinDek® panel is a stamped part number. When correctly installed, the stamp will be right side up.
- With weight on the top of the panel, use a 17/64" (6.8mm) stopper bit to drill holes from the bottom through the corrugated and into the ResinDek® panel. Underside fasteners / fixings should be installed into holes using an approved pneumatic tool. If one was not provided contact Cornerstone Specialty Wood Products, LLC®.
- Secure each panel with a minimum of four underside fasteners / fixings before installing the next panel. **INSTALL UNDERSIDE FASTENERS / FIXINGS SO THAT THE HEAD IS TIGHT TO THE BOTTOM SIDE OF THE CORRUGATED DECK.**
- Attach panels to corrugated deck or other approved sub-flooring using a minimum of 20 underside fasteners / fixings per 4' x 8' (1.22m x 2.44m) sheet. (See **Figure A**) For best results, use ResinDek® Invisi-Loc® underside fasteners / fixings furnished by Cornerstone Specialty Wood Products®.
- Fasteners / fixings should be located a minimum of 1" (25mm) from panel edge. Remove metal panel spacers and insert between next panels.
- ResinDek® panels are a wood based product and may expand over time. Therefore, you must leave an 1/8" (3mm) minimum gap between ResinDek® panels. The gap on the outer edge (perimeter) must not be less than a 1/4" (6mm) or exceed a maximum of a 1/2" (12mm) Attached to each ResinDek® bundle is a package that includes installation instructions and three 1/8" (3mm) thick metal panel spacers. Between all adjacent panels insert the metal spacers, two along the long edge and one along a short edge, to ensure proper gapping between the panels. **FAILURE TO USE METAL PANEL SPACERS MAY ALLOW FLOOR TO BUCKLE AND WILL VOID ALL WARRANTIES.**
- It is essential to trim the last row of panels to allow for a 1/4" (6mm) to a 1/2" (12mm) gap along the outer edges of the ResinDek® floor perimeter. You can trim ResinDek® panels to size with a circular saw. Carbide tip blades are recommended for best results.
- To avoid weak joints that may damage your floor, take caution to lay the panels down with the joints over the ribs whenever possible. Panels must be cut back, or placed on top of a minimum 6" (152mm) wide, 20-gauge valley shim, when ResinDek® panels break on a valley (**Figure B**). These valley shims can be obtained from Cornerstone Specialty Wood Products. Do not use wood blocks in the valley of the decking, as they may cause the panel joints to become uneven. **PLACING RESINDEK® PANEL JOINTS WITHOUT PROPER VALLEY SHIMS WILL VOID YOUR WARRANTY.**
- **NOTE: GROUNDING SCREWS MUST BE USED WITH ANY RESINDEK® ESD COATED PANELS (GRAY DIAMOND SEAL® 2 ESD OR TRIGARD®).**

**Figure A - Corrugated Deck Grid Pattern for Invisi-Loc®**

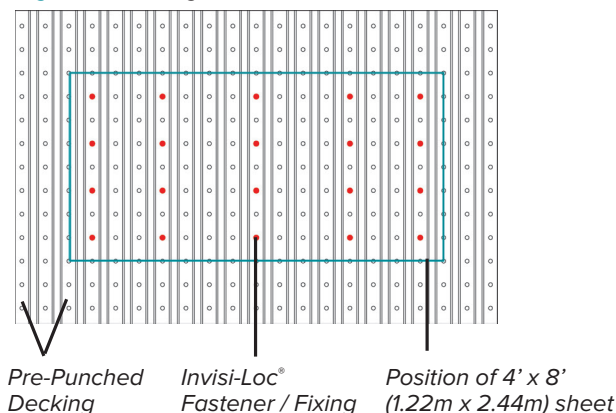

**Figure B.**

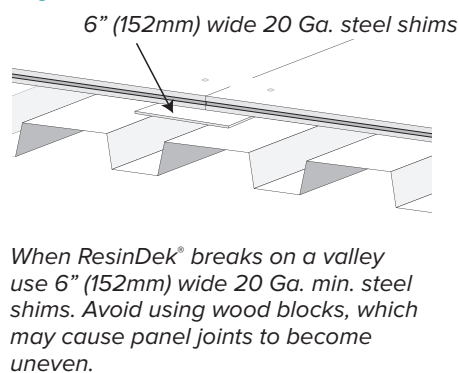

**Invisi-Loc® Fastener / Fixing**



**Part No. COR8040 for 1-1/8" (25mm) Xspan & Part No. COR8028 for 3/4" (19mm) Panels**





## ResinDek® Flooring Panel Installation (cont.)

### ResinDek® with MetaGard® Top Side Fasteners / Fixings in Corrugated Metal Deck

CONFIRM THAT THE WEIGHT OF THE UNIT WILL NOT EXCEED THE CAPACITY OF THE PANEL PRIOR TO MOVING IT ACROSS A FINISHED RESINDEK® FLOOR. THESE VALUES ARE BASED ON A STANDARD MANUAL PALLET JACK.

| Product                       | Weight (psf) / (kg/m <sup>2</sup> ) | Pcs per Unit | Weight per Unit for 4'x6' (1.22m x 2.44m) panels (lbs) / (kg) | Weight per Unit for 4'x8' (1.22m x 3.05m) panels (lbs) / (kg) | Rated Pallet Jack Load Capacity (lbs) / (kg) |
|-------------------------------|-------------------------------------|--------------|---|---|--|
| ResinDek® LD MetaGard®        | 4.2 (20.5)                          | 32           | 3,226 (1,463)   | 4,301 (1,951)   | 2,500 (1,134)                                |
| ResinDek® SD MetaGard®        | 4.5 (22.4)                          | 32           | 3,456 (1,595)   | 4,608 (2,127)   | 3,000 (1,361)                                |
| ResinDek® MD MetaGard®        | 4.9 (23.9)                          | 32           | 3,763 (1,704)   | 5,018 (2,271)   | 3,500 (1,588)                                |
| ResinDek® HD MetaGard®        | 5.2 (25.4)                          | 32           | 3,994 (1,916)   | 5,325 (2,555)   | 4,500 (2,041)                                |
| ResinDek® Xspan® MetaGard®    | 6.6 (32.3)                          | 21           | 3,326 (1,511)   | 4,435 (2,015)   | 2,300 at 32" O.C.<br>(1,043 at 810mm O.C.)   |
| ResinDek® Xspan® FR MetaGard® | 7.4 (36.4)                          | 21           | 3,730 (1,703)   | 4,973 (2,271)   | 3,000 at 32" O.C.<br>(1,360 at 810mm O.C.)   |

We recommend wearing gloves when handling ResinDek® panels with MetaGard® and proper PPE (Personal Protective Equipment) when cutting and installing panels with MetaGard®.

**PLEASE NOTE: THE INSTALLATION OF RESINDEK® WITH METAGARD® IS THE SAME AS PAGE 4 WITH THE FOLLOWING EXCEPTIONS:**

- ResinDek® panels with the MetaGard® steel surface does not require gapping between panels. Anywhere a ResinDek® panel with MetaGard® adjoins a non MetaGard® panel, an 1/8" (3mm) gap is still required between the panels.
- Be sure to trim the last row of panels to allow for a 1/8" (3mm) gap along the outer edges of the ResinDek® MetaGard® floor perimeter. You can trim ResinDek® MetaGard® panels to size with a circular saw. For best results use a 3000-4000 RPM saw with high speed steel blades or carbide tip blades that are 7-1/4" (178mm) diameter with 24 - 40 teeth. **FOR SAFETY REASONS DEBURR THE CUT EDGE WITH A GRINDER OR FILE.**
- Before securing ResinDek® MetaGard® panels to the corrugated metal deck, it is necessary to countersink the screws using a countersink bit (**Figure A**). Countersink bits are available to purchase through Cornerstone Specialty Wood Products. A 2500 – 3000 RPM drill is recommended for the countersinking process. For more information please contact Cornerstone Specialty Wood Products at 513.772.5560.
- Drive screws so that the top is just below the ResinDek® MetaGard® panel surface (**Figure B**). Proper screw head depth is critical to performance and appearance of your ResinDek® MetaGard® floor.

**Figure A.**  
Example of Countersink Bit



**Figure B.**

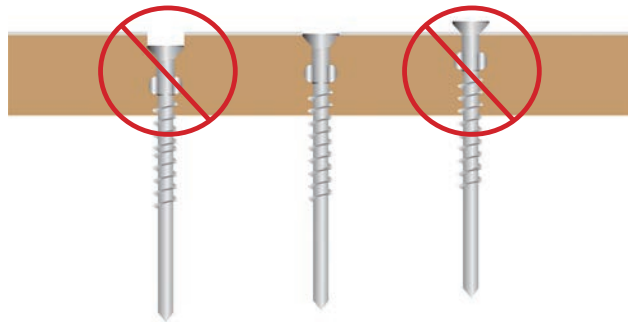



## ResinDek® Flooring Panel Installation (cont.)

### ResinDek® with Xspan® and Xspan® FR

ResinDek® Xspan® and Xspan® FR do not need corrugated metal deck and should be installed over existing supports (bar joists/beams). ResinDek® is not intended for exterior applications. ResinDek® panels must be kept dry in transit and storage. Panels should be stored flat in a level position. **RESINDEK® PRODUCTS NOT INSTALLED IN ACCORDANCE WITH THE FOLLOWING INSTRUCTIONS WILL VOID ALL WARRANTIES.**



#### ResinDek® Xspan® and Xspan® FR Installation Process:

- Begin Installation by setting a true line with a laser or transit less than 48" (1219mm) from one edge of the mezzanine.
- Leave a minimum of a 1/4" (6mm) gap to a maximum 1/2" (12mm) gap on the outer edges of ResinDek® Xspan® and Xspan® FR and and leave an 1/8" (3mm) gap between ResinDek® panels.
- Trim the last row of panels to allow for 1/4" (6mm) to a 1/2" (12mm) gap on outer edges of ResinDek® Xspan® and Xspan® FR perimeter.
- Attached to each unit of ResinDek® is a package of 3 panel spacers. Insert metal spacers (2 along one long edge, 1 along short edge) between all adjacent panels. **FAILURE TO USE METAL PANEL SPACERS MAY ALLOW FLOOR TO BUCKLE AND WILL VOID ALL WARRANTIES.**
- Attach panels to supports using a minimum of 20 fasteners / fixings per 4' x 8' (1.22m x 2.44m) sheet. (See figure E below) For best results, use ResinDek® Xspan® and Xspan® FR Drill Screws furnished by Cornerstone Specialty Wood Products, LLC®. Fasteners / fixings should be located a minimum of 1" (25mm) from panel edge. Remove panel spacers and insert between next panels.
- Be sure that panels are installed with correct face on top. Each panel has a ResinDek® label that identifies the part number. When correctly installed, the ResinDek® label will be right side up. The panels should have a space of a panel spacer's width around the perimeter of each ResinDek® panel.
- Stagger panels so that joints break on different supports whenever possible.
- ResinDek® Xspan®/Xspan® FR can be installed with the long direction parallel or perpendicular to the supports.
- All panel joints should break in the middle of a support (see Figure F below) and not exceed approved spans from center to center. **SEE THE RESINDEK® Xspan® and Xspan® FR LOAD TABLES BELOW FOR WARRANTABLE SPANS.** Fasteners / fixings must be long enough to penetrate both the ResinDek® Xspan® and the bar joists. Secure each panel with a minimum of four fasteners / fixings before installing the next panel. Use only screw guns with a nose clutch to countersink screw heads. **DRIVE FASTENERS / FIXINGS SO THAT THE COUNTERSUNK HEAD IS JUST BELOW THE PANEL SURFACE.**
- ResinDek® Xspan®/Xspan® FR can be trimmed to size with ordinary power saws. Use carbide tipped blades for best results.
- For underside fastening, see Invisi-Loc® Fastening System Installation Instructions.

#### ResinDek® Xspan® & Xspan® FR - Allowable Uniform Loads (based on a two span condition) and Maximum Pallet Jack Live & Dead Load Capacity (includes weight of pallet jack) - DO NOT EXCEED Maximum and Uniform Loads

| Span (Inches) / (mm)   | 16 (406)      | 24 (610)      | 32 (813)      | 40 (1,016)    | 48 (1,219)  |
|--|---------------|---------------|---------------|---------------|-------------|
| Maximum Pallet Jack Capacity for ResinDek Xspan (lbs) / (kg)     | 3,000 (1,361) | 2,700 (1,225) | 2,300 (1,043) | 2,000 (907)   | 1,500 (680) |
| Maximum Pallet Jack Capacity for ResinDek Xspan FR (lbs) / (kg)  | 3,800 (1,724) | 3,500 (1,588) | 3,000 (1,361) | 2,600 (1,179) | 2,000 (907) |
| Allowable Uniform Load for ResinDek Xspan (lbs/ft2) / (kg/m²)    | 375 (1,830.9) | 225 (1,098.6) | 125 (610.3)   | 75 (366)      | 50 (244.1)  |
| Allowable Uniform Load for ResinDek Xspan FR (lbs/ft2) / (kg/m²) | 450 (2,197.1) | 350 (1,708.9) | 275 (1,342.7) | 175 (854.4)   | 125 (610.3) |

**Figure E -**  
Fastener /  
Fixing  
Pattern

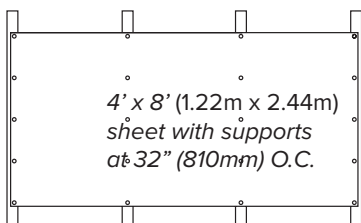

**Figure F - Typical ResinDek®  
Xspan® & Xspan® FR Chan-  
nel/Beam Installation**

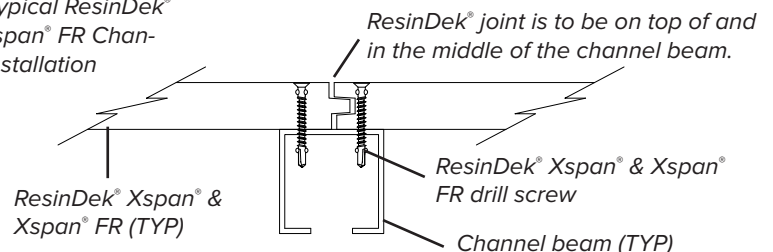



**CORNERSTONE**  
SPECIALTY WOOD PRODUCTS, LLC®

12020 Tramway Drive  
Cincinnati, OH 45241  
Toll Free: 888.755.3048 | Tel: 513.772.5560  
Email: [info@resindek.com](mailto:info@resindek.com) | [www.resindek.com](http://www.resindek.com)



Storage Manufacturers  
Association

